

CR-2

Countertop Sparkling & Chilled Still Water Dispenser



Commercial countertop beverage dispensing unit that provides cold-carbonated sparkling water and chilled still water. Self-contained refrigeration with European design stainless steel exterior. Suitable for high-volume service stations and hospitality applications.







Features

- Cold carbonation at up to 80 liters/hour (<40°F)
- Dual-water dispensing (sparkling + chilled still)
- High-efficiency self-contained refrigeration
- Durable 304 stainless steel exterior*
- Bottle fill station with 12" clearance
- Flow control faucets

R290



Accessories

- Water filter system (required):
 - CR-24FC: Twin filter system, compact fibredyne filters, reduce chlorine, taste, odor, color while retaining the good minerals that are essential for bottle quality tasting water, 19"H x 17"W, 5 gpm, 30,000 gal, TOC & ½ micron filtration 
 - CR-24FCP: Twin filter system with prefilter, compact fibredyne filters, reduce chlorine, taste, odor, color and organic chemicals while providing exceptional sediment reduction with resistance to premature plugging, 19.25"H x 21.75"W, 5 gpm, 30,000 gal, TOC & ½ micron filtration
- Install kit (required):
 - CR-KIT-CT: Installation kit for countertop units, CR-1 & CR-2, includes fittings and oetiker clamps and extra tubing to install the filter systems and countertop unit 
- Dispense levers:
 - CR-SDL-1: Single sanitary dispense lever that attaches to a self-closing faucet on unit. 1 per faucet. Great for self-service hands-free dispensing applications 
- CO2 regulators:
 - CR-PC160-14FCV: Primary high pressure CO2 regulator for CO2 tank 
 - CR-S115-14FCV: Secondary CO2 regulator for bulk CO2 supply
- Wall brackets:
 - CR-CWB1: Single CO2 gas cylinder wall bracket 
 - CR-CWB2: Twin CO2 gas cylinder wall bracket
- Cylinder auto change over device:
 - CR-CTAC2: CO2 cylinder auto change over device. Connects two cylinders at one time to double CO2 capacity 

CR-2

Countertop Sparkling & Chilled Still Water Dispenser



Scan for more resources!

Line Drawings

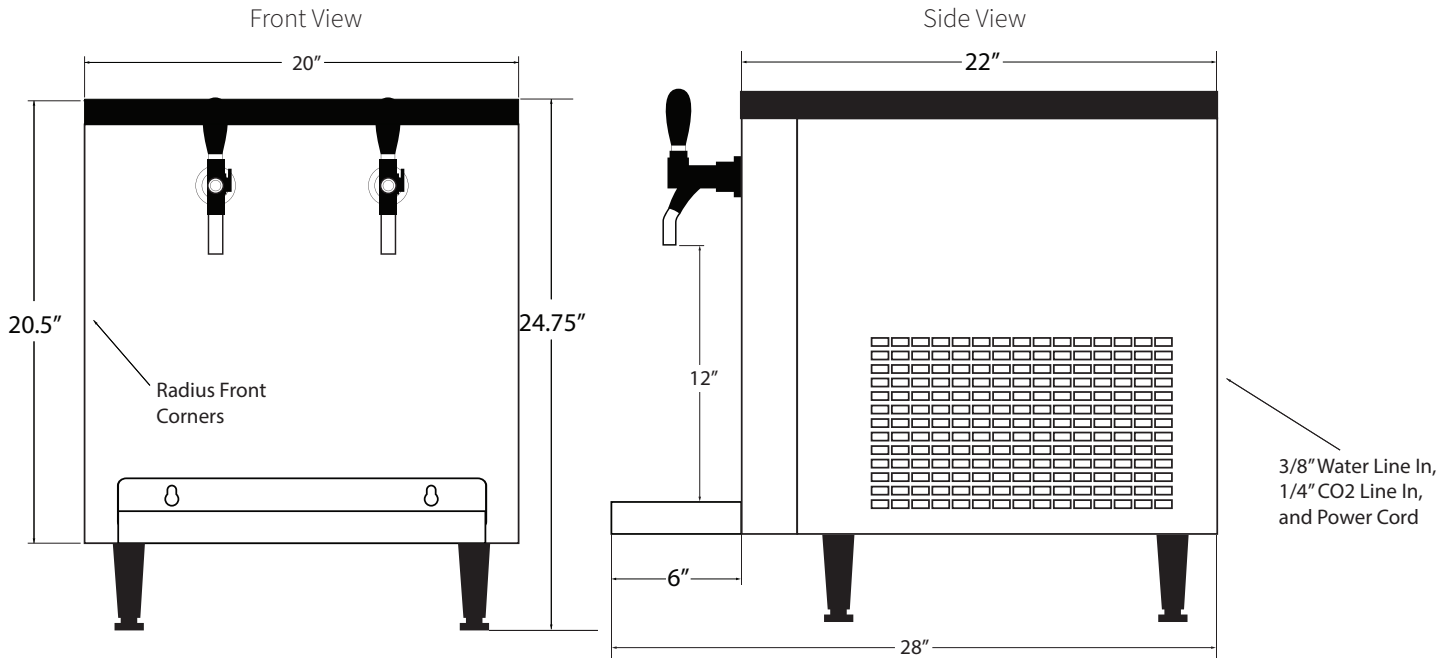

- 3/8" Water inlet push in fitting at bottom of machine
- 7' Over flow drain hose
- 7' CO2 hose 1/4" flare fitting
- 9' Electrical cord NEMA 5-15
- 4.0" - 5.5" adjustable legs
- Air intake at rear with air filter
- Allow for 6" side clearance for air flow out
- Allow for 3" of rear clearance for air flow in

Capacity	80 liters/hour (<40°F)
Refrigerant	R290
Width	20"
Depth	28"
Height	24.75"
Bottle fill clearance	12"
Compressor	1/3 H.P.
Carbonator	1/3 H.P.

Operating temp	40°F-100°F
Electrical	120v - 14.4 Amps
BTU Output	~2,600 BTU/hr
Water bath	6 gal
Ice bank	25 lbs
Weight	165 lbs