



Project:

Scan for more info!



Owners Manual
Quick Install
Quick Sizing
Install Layout
Parts List

CBR-V2
Series Draft Tower



Sparkling & Chilled Water
2 Valve Tower Options:

- CBR-V2C Chrome Finish**
- CBR-V2WHT White Finish**
- CBR-V2BLU Blue Finish**
- SLF Self Service set-up**

Specifications

- **For Self Service configuration add -SLF to the end of the model number**
- **Faucet Flow Rate: 1.5-2 oz per second**
- **Two faucets for Sparkling and Chilled water**
- **Overall Height: 20.25"**
- **12.5" Bottle Clearance: from bottom of spout to table top**
- **Supplied with quick connect fittings for easy hook-up to our CR-4L38 trunkline**
- **Ergonomic Handles**

Tower to Trunk Line Hook-Up

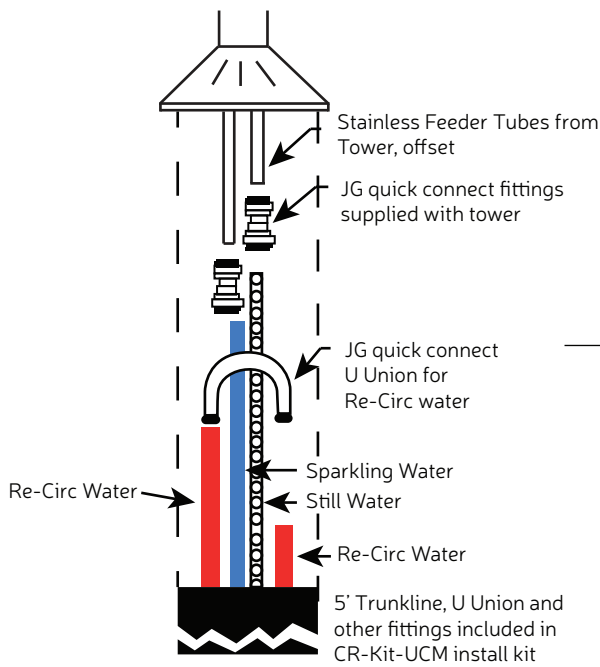
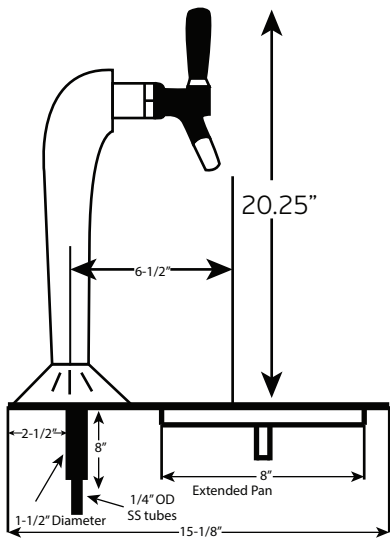

Tower to Drain Pan, hole cut and dimensions

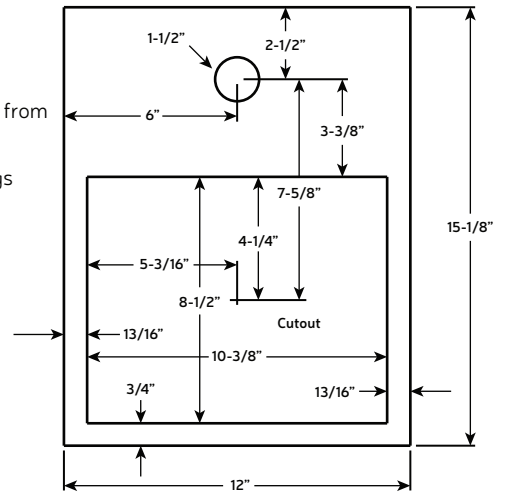

Required Accessories Checklist:

DP-CT

Stainless Countertop Mount drain pan



Configured with a drain tube for direct plumbing

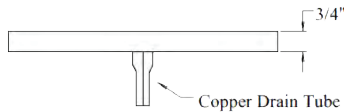

Or with rubber feet when no drain is available:

DP-CT-L/D

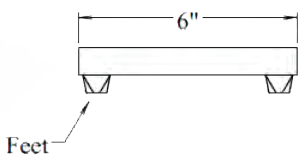

CR-100301-C

Optional Chrome Handles:

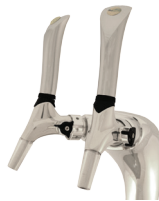

RDP-1

Recessed Drain Pan



Overall 12" Wide x 15-1/8" Deep

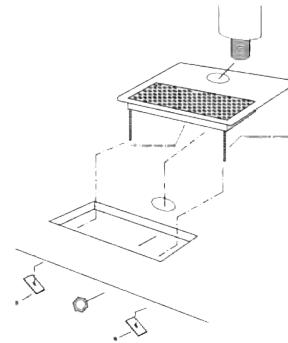

NSF Certified under NSF/ANSF Standard 18

